

REV.	DESCRIPTION	DATE
A	NEW DRAWING	2/13/2008

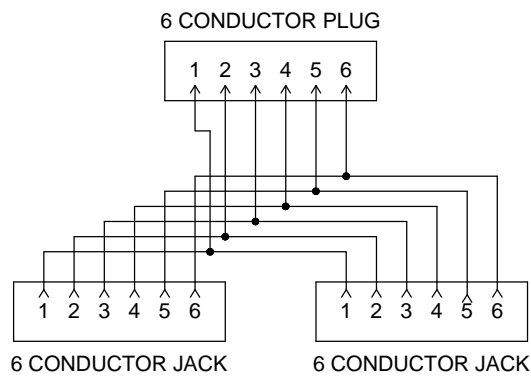

WIRING SCHEMATIC

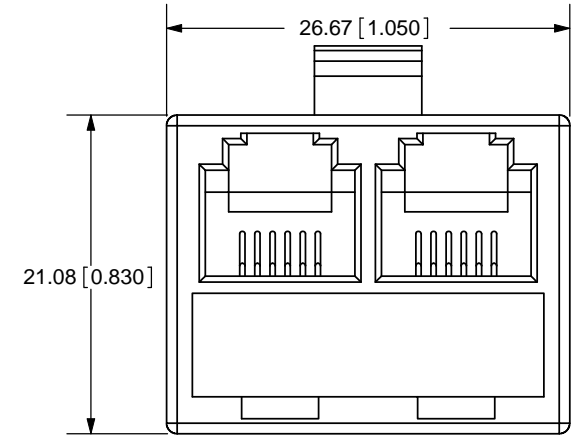
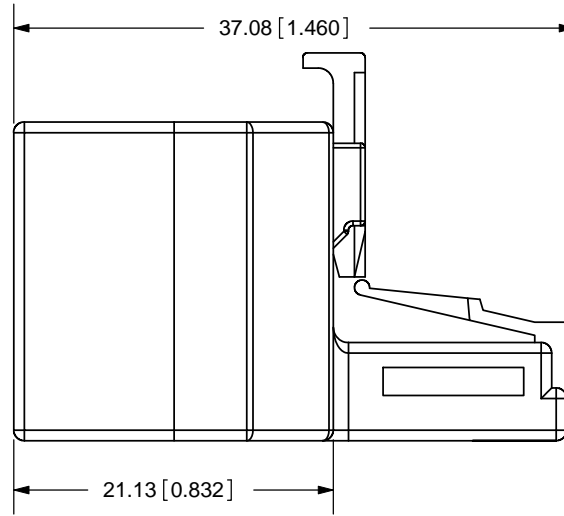
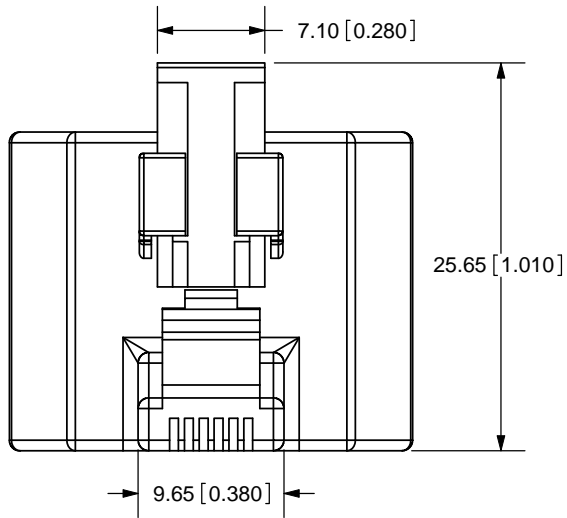
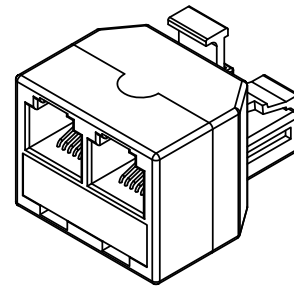

SCALE: 1:1

TOLERANCE:
±0.3mm UNLESS OTHERWISE
SPECIFIED



20050 SW 112th Ave.
Tualatin, OR 97062
Phone: 503-612-2300
800-275-4899
Fax: 503-612-2383
Website: www.cui.com

TITLE: MODULAR T-ADAPTER, 6 CONTACT		REV: A
PART NO. AMK-0051	UNITS: MM [INCHES]	
DRAWN BY: ZRJ	APPROVED BY:	SCALE: 2:1

	MATERIAL	PLATING
CONTACTS	Phosphor Bronze	Gold over Nickel
HOUSING	ABS	

PC FILE NAME:
AMK-0051

COPYRIGHT 2008 BY CUI INC.